

水槽 KE - R15 Vintage



水槽

代码: 2157 080



细节

材料 AISI 304 不锈钢

质地 Vintage

边型和安装方式 平嵌

底座 80 cm

尺寸 750 x 440 mm

标准配件 固定钩, 垫圈, 下水器, 溢水口和虹吸管, 纸板盒包装

龙头孔 无定位孔

安装孔 [View technical data sheet](#)

下水器 否

宽 75 cm

盆内尺寸 710 x 400 mm

单槽/双槽 单槽

下水组件 3,5" 下水器

特点

3.5" 下水器提篮 Foster®水槽均配备了3.5"下水器，有可防止固体颗粒流入下水器的实用篮式塞。3.5"下水器允许使用Foster®碎渣机，可与所有型号兼容。

小倒角 具有现代设计和更大容量的方形碗，具有最小的美观性和极高的实用性。

溢水口 溢水口是Foster水槽上的一项安全措施，可以防止疏忽时水的溢出。方形溢水解决方案，具有简约的方形，更加美观大方。

老式 复古外观赋予产品长久而优雅的外观，形成了不怕刮擦的表面。

高厚度 1mm厚的钢。相当大的厚度，保证了最大的坚固性和耐用性。

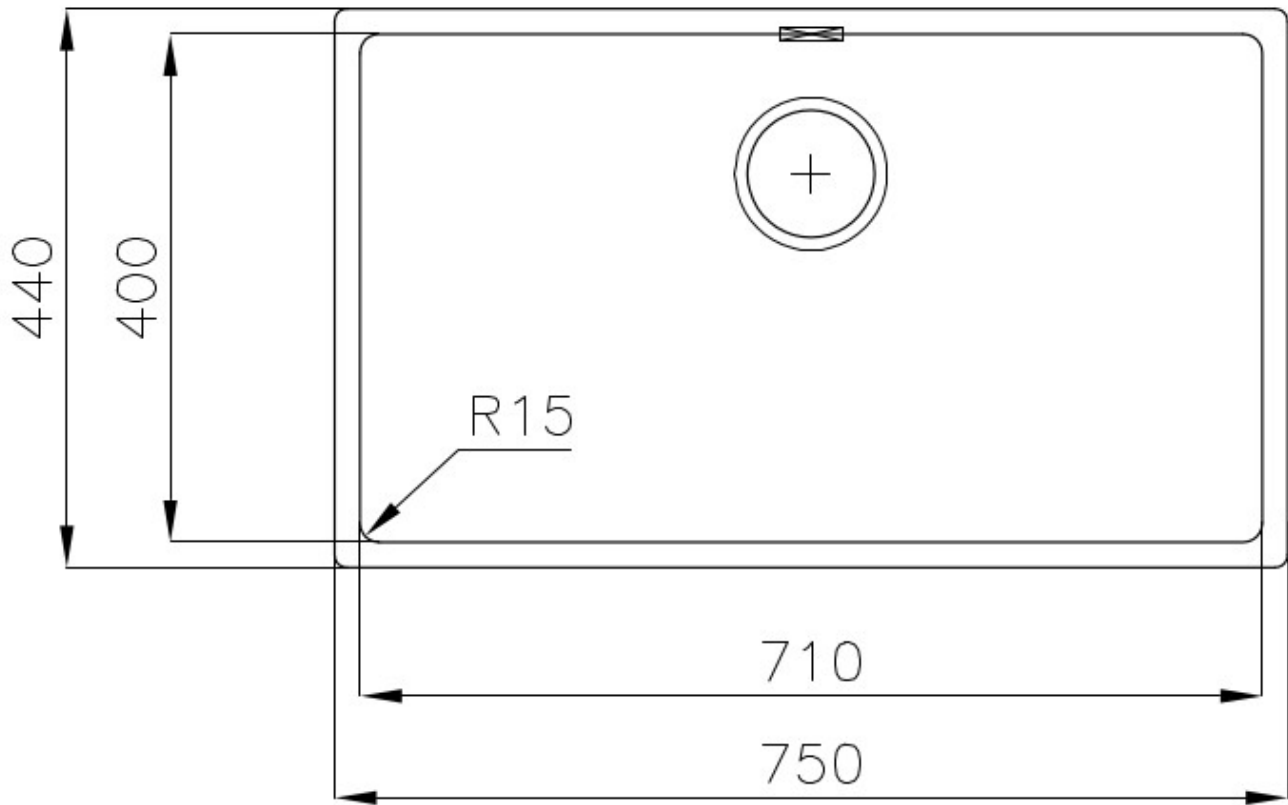
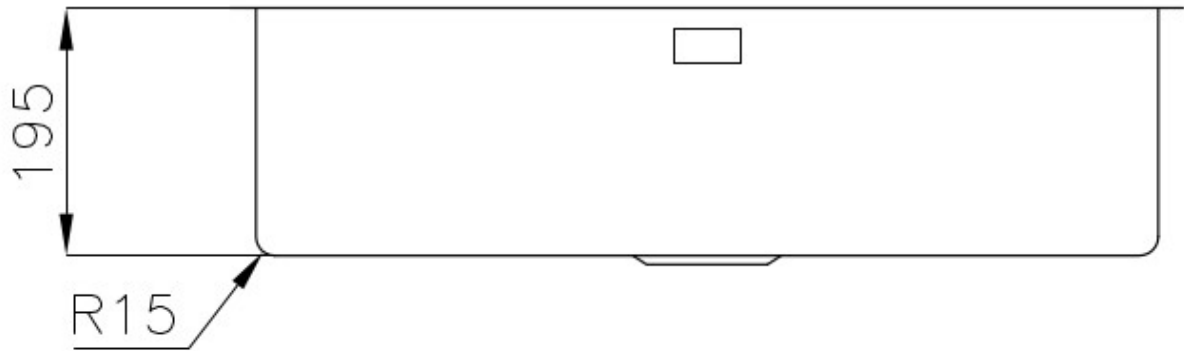

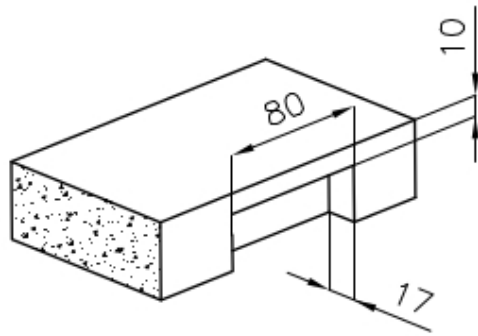

Intaglio per il troppo-pieno
Recess for housing the over-flow

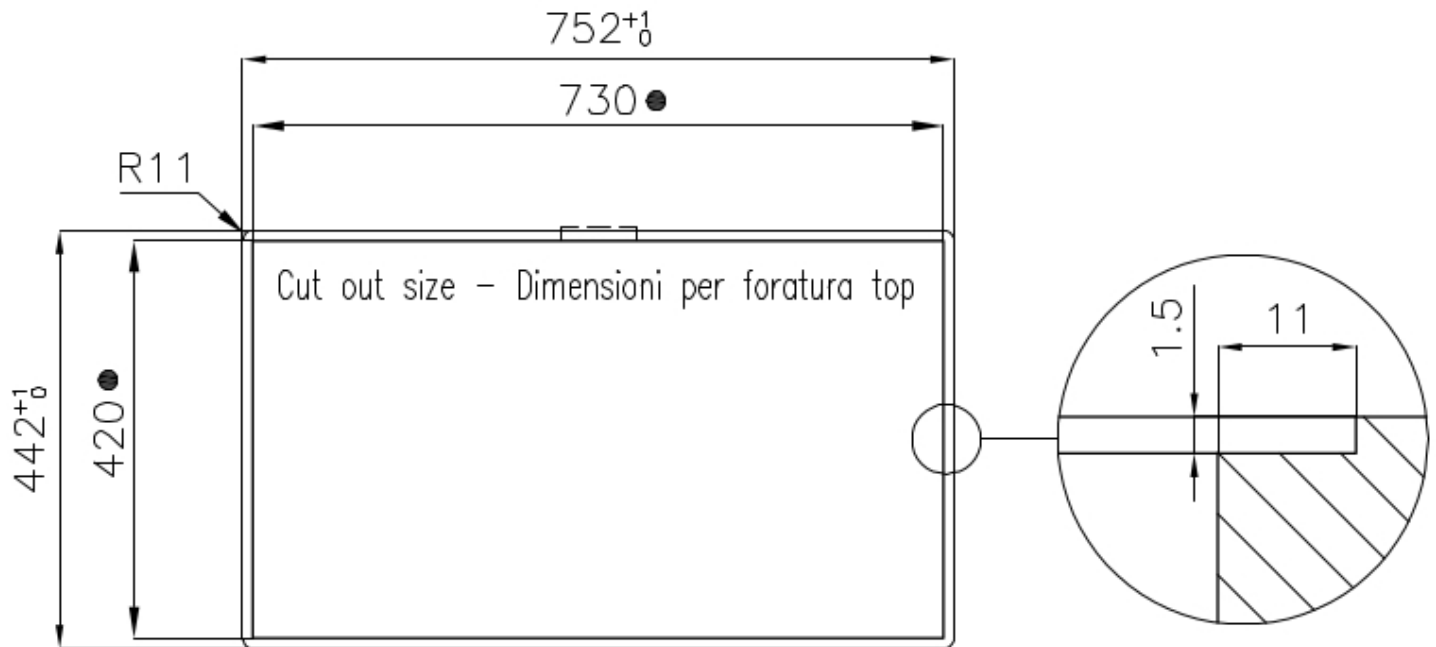

- Built-in cut out for FTS – Foratura per installazione FTS



OPTIONAL ACCESSORIES



HPDE Twin 砧板
8644 101



HPDE 砧板
8657 001



不锈钢篮
8612 000



不锈钢背板
8100 154



不锈钢背板
8100 303
* 仅与附件结合使用 8644 101



不锈钢背板
8100 201



玻璃砧板
8631 300



白托盘
8153 100

RECOMMENDED PAIRINGS



龙头 **Bert**
8428 100



龙头 **KE**
8492 000

OPTIONAL AUTOMATIC WASTE FITTINGS



Milano 自动下水器 **Space**
8407 115



自动下水 - **PM**
8407 113



自动下水器 **Space - PA**
8407 108



自动下水器 **Space - PL**
8407 117



自动下水器 **Space - PP**
8407 116



自动下水器 **Space - PE**
8407 109